

MPPC17 Celeron Maritime Panel PC configurable

The Maritime Panel PC 17" Celeron provides cost efficient performance for demands of latest software generation for vessels and other maritime applications. As you would expect, it is tested according to IACS E10 as well as EN 60945 for bridge use, approved by GL and DNV. The MPPC17 Celeron is available with antireflex glass or with resistive touch screen, suitable for marine applications, with a choice of the latest Operating Systems and with DC or (and) AC power supply. Standard options like flash memory, speakers, alarm buzzer, I/O Interfaces and others can be easily configured for most applications. Individual options and customer specific features ensure that most requirements can be fulfilled.

Sonove Services

- ✓ Customer-specific Front Design
- ✓ Different OS
(e.g. Windows, Linux, etc.)
- ✓ Customer-specific Images
- ✓ Individual Software Development
(Embedded, HMI/SCADA, protocols, etc.)
- ✓ Customized Systems (HW / SW)
incl. GL/DNV certification (including one off designs)
- ✓ Individual Turn Key Solutions
(HMI/SCADA, Control, IEC61131, etc.)



Technical Data MPPC17 Celeron

17" TFT Display widescreen 5:4,
resolution 1280 x 1024,
brightness: 300 cd, LED Backlight
contrast 1000:1
antireflex glass / resistive touch
IP67 front, IP40 back

CPU: Intel® Celeron®, 2 x 2.2 GHz
RAM 2/4/8/16 GB
SSD 64/128/256 GB

2 Ethernet 1 Gbit/s
4 USB, 2 available at the front
4 RS232 / 485 galv. Isolated

Options:

- Alarm Buzzer, 2 x speaker 2W
- Ext. Slots: CAN, Mini PCIe, PC104+

Power supply:
18-32 VDC / 88-264 VAC / redundancy

Temp. -15 to +55°C

Type Approvals:
GL, DNV
EN 60945

Sonove GmbH
Hindelanger Str. 33
87527 Sonthofen
Deutschland

Tel. +49 8321 67466 200
Fax +49 8321 67466 199
marine@sonove.com

MPPC17 Celeron Maritime Panel PC drawings and order informations

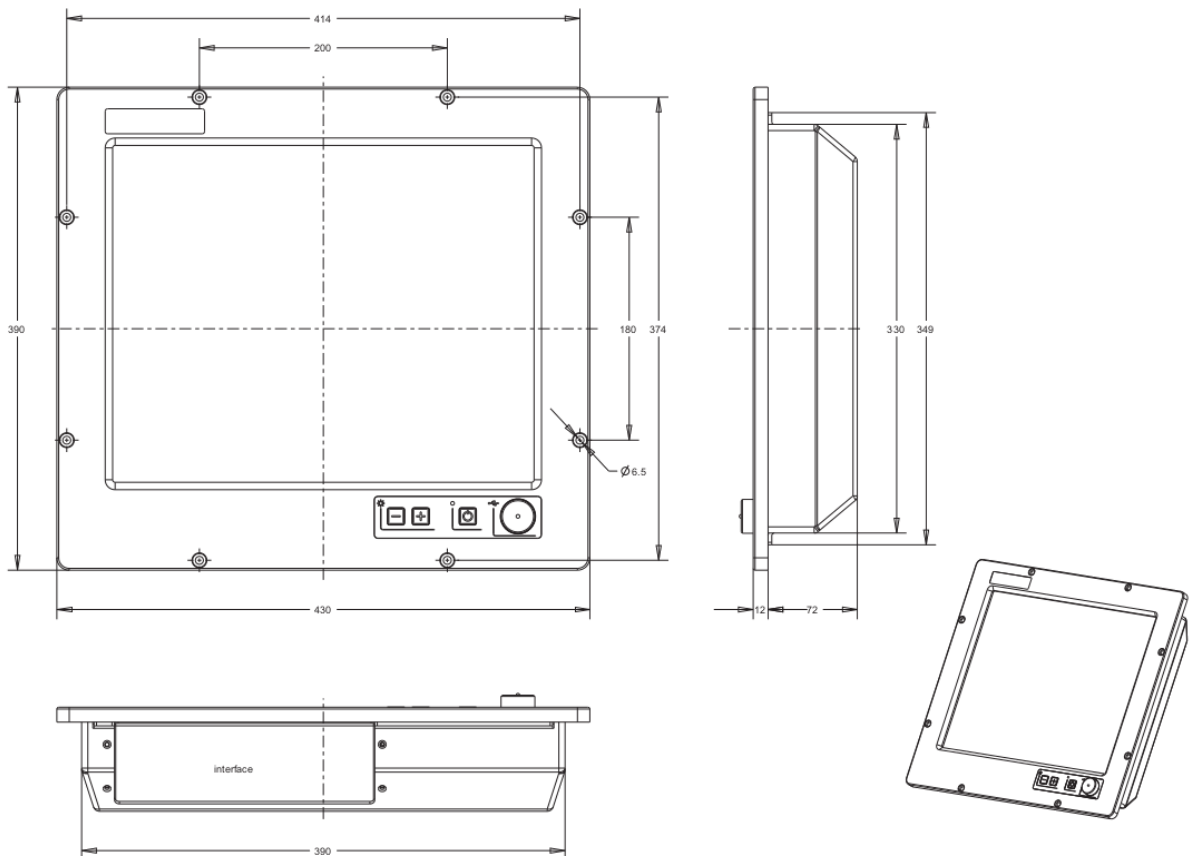

Order information

Marine Panel PC 17 Celeron

MPPC17 Celeron Glass	450.000.0001	Marine Panel PC, Intel® Celeron®, 2 x 2.2 GHz, 17" TFT, antireflex glass
MPPC17 Celeron RT	455.000.0001	Marine Panel PC, Intel® Celeron®, 2 x 2.2 GHz, 17" TFT, resistive touch

Configuration

Power Supply

Power supply 18-36 VDC	400.002.0000	18-36 VDC, 100W
Power supply 88 - 264 VAC	400.001.0000	88-138 VAC / 176-264 VAC, 150W

Flash Memory

SSD 64 GB	400.010.0000	Solid State Disc, 64 GB
SSD 128 GB	400.020.0000	Solid State Disc, 128 GB
SSD 256 GB	400.030.0000	Solid State Disc, 256 GB

Operating System

Microsoft Windows® desktop	Windows® 7 Ultimate 32/64 Bit, Professional 32/64 Bit Windows® XP Pro Embedded SP 3, Windows® 10 (soon)
Microsoft Windows® embedded	Windows® 7 emb., Windows® XP emb., Windows® 10 (soon)
More ...	Request e.g. other Microsoft, Linux, Customized, etc.

Optional

Acoustics

Alarmbuzzer	400.000.0001	alarm buzzer, 85 dB
Speaker, 2W	400.000.0002	2 x 2W RMS

Interface / Extension / Customized

More ...	Call us, we'll design your solution
----------	-------------------------------------

Sonove GmbH
Hindelanger Str. 33
87527 Sonthofen
Deutschland

Tel. +49 8321 67466 200
Fax +49 8321 67466 199
marine@sonove.com

www.SONOVE.com